

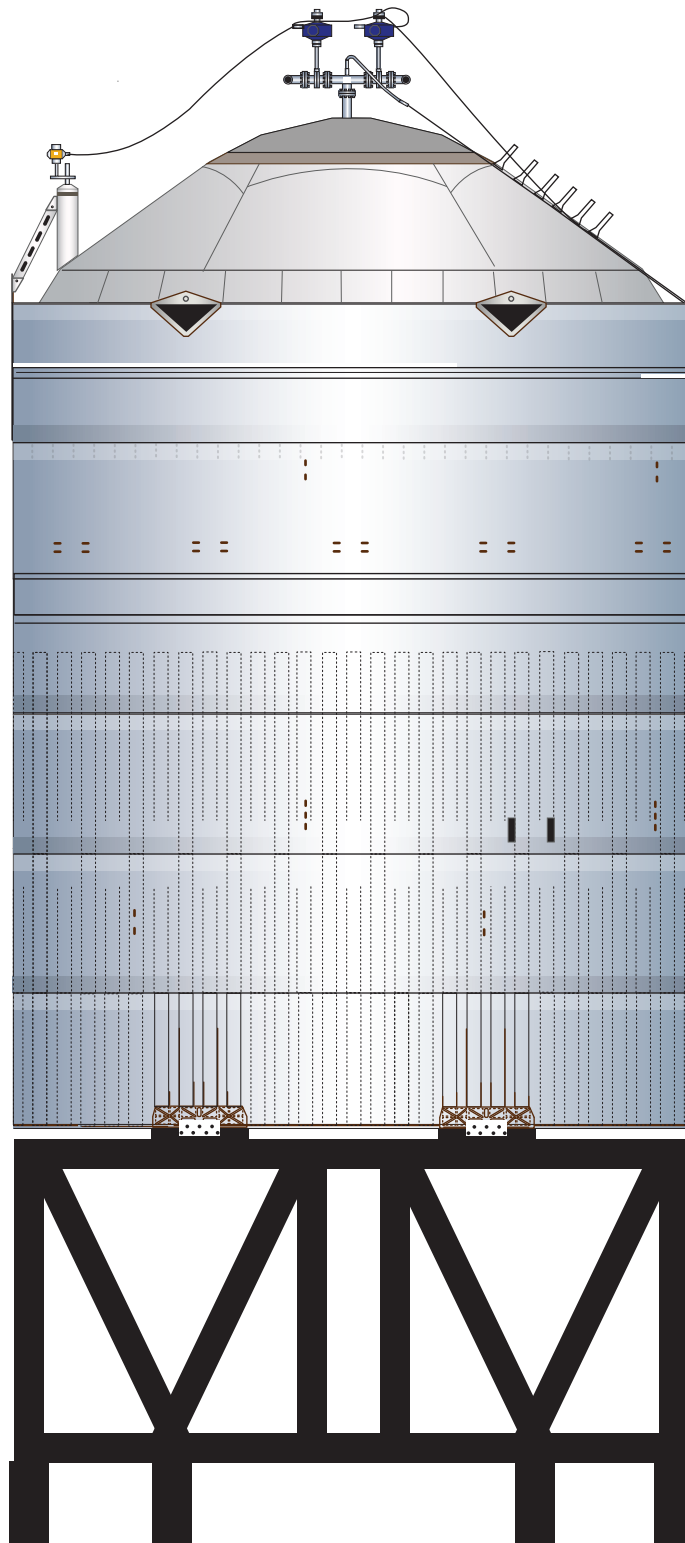

# SN 7.1

1:100 Scale



S  
T  
A  
R  
S  
H  
I  
P

Designed by Alfonso X Moreno  
©2020 Not for commercial use



1 cm  
1 inch

# SpaceX Starship SN 7.1

Print on Cardstock (110 lbs)

REFERENCE

NOT TO SCALE

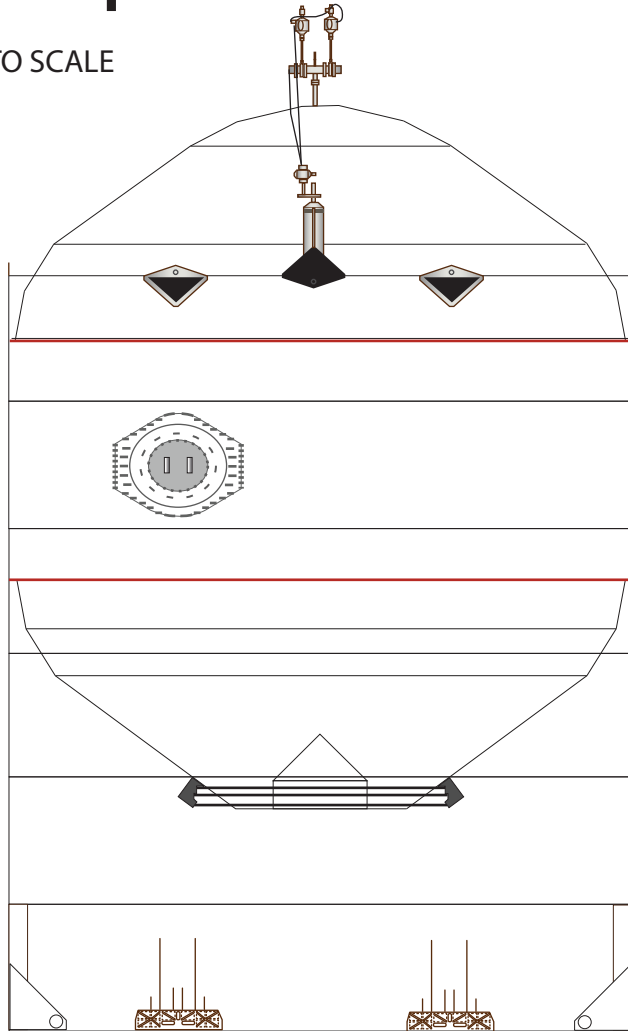

Front

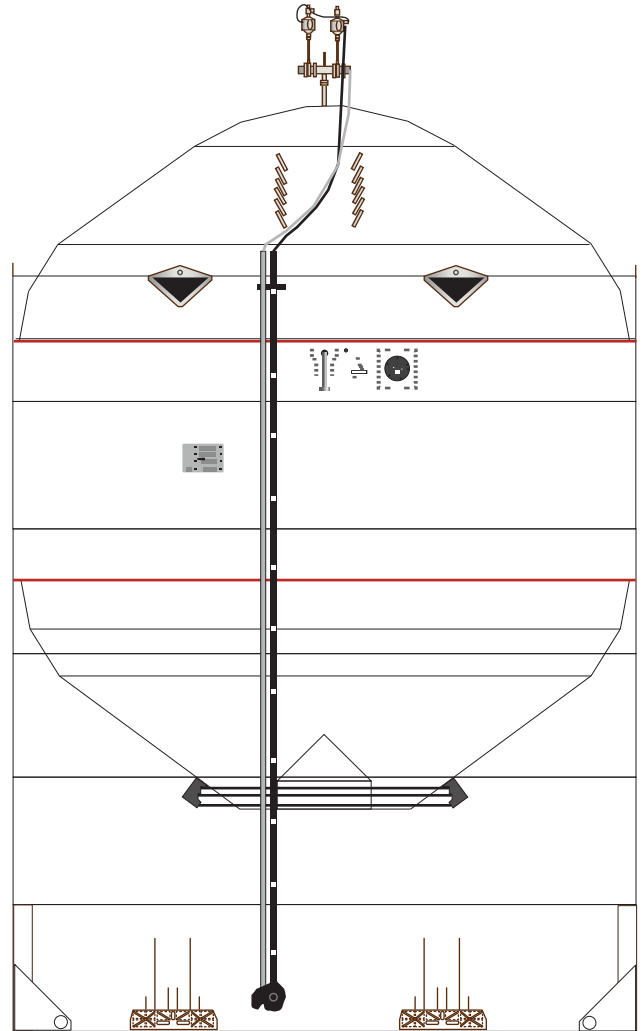

Back

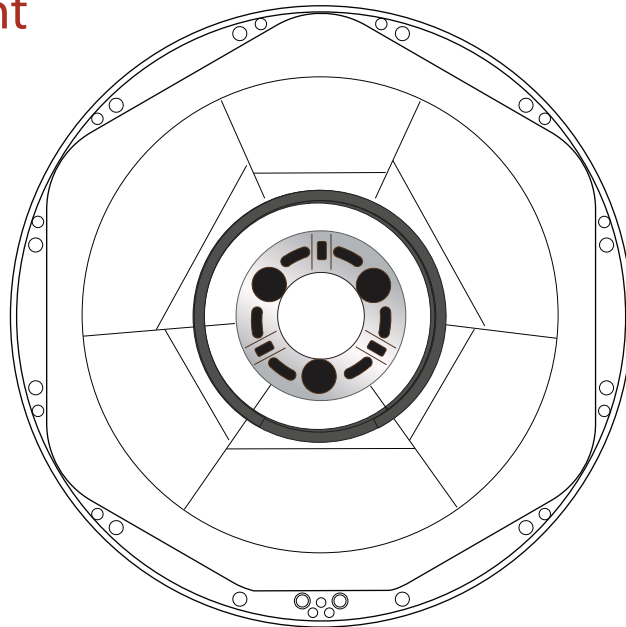



1 cm

1 inch

1:100 Scale

# Starship SN 7.1 Upper Dome

Print on Cardstock (110 lbs)

Revised

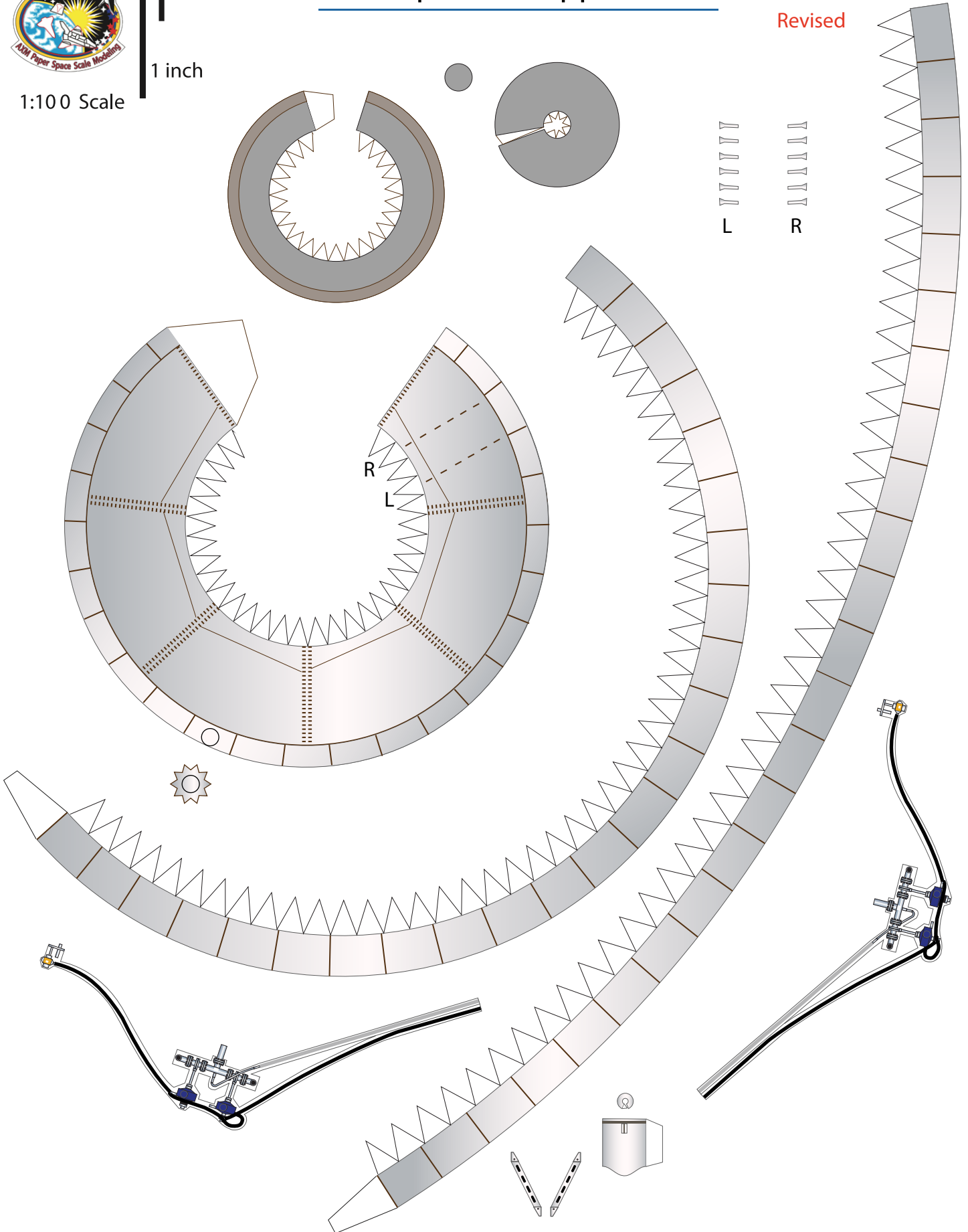

L

R



1:100 Scale

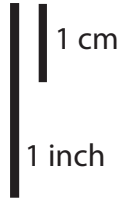

# SpaceX Starship SN 7.1

Print on Cardstock (110 lbs)

## Former for upper dome

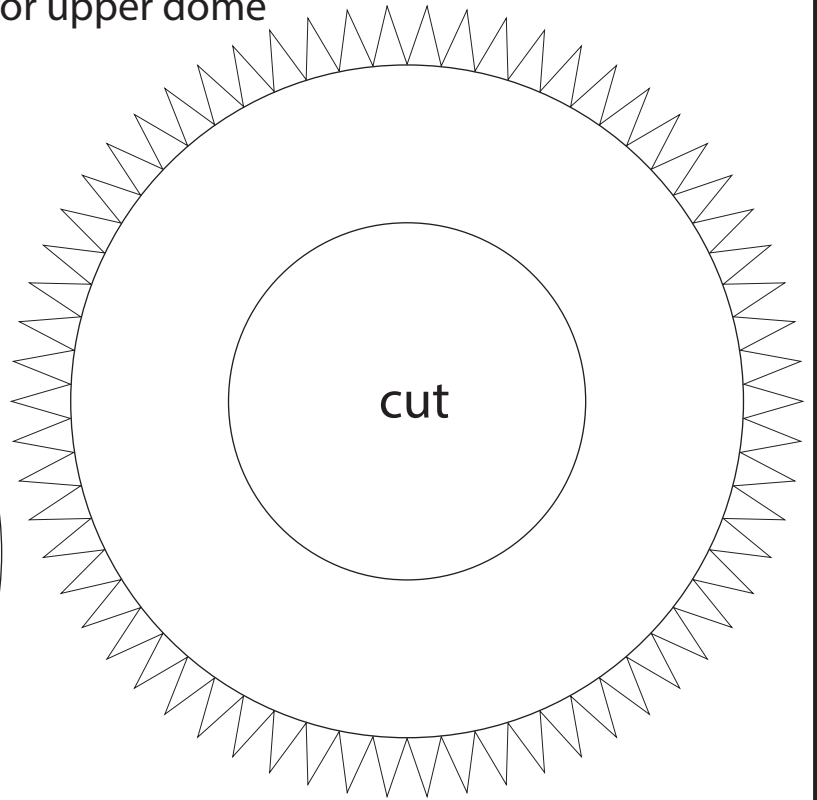
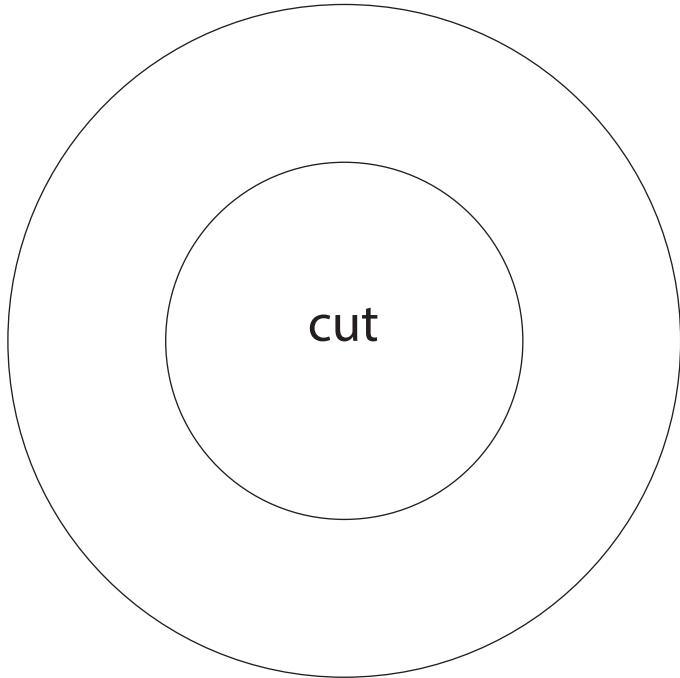

**IMPORTANT**  
Top former is glued 10 mm from top edge of upper body for Starship SN 7.1 model

### Leg support pillars

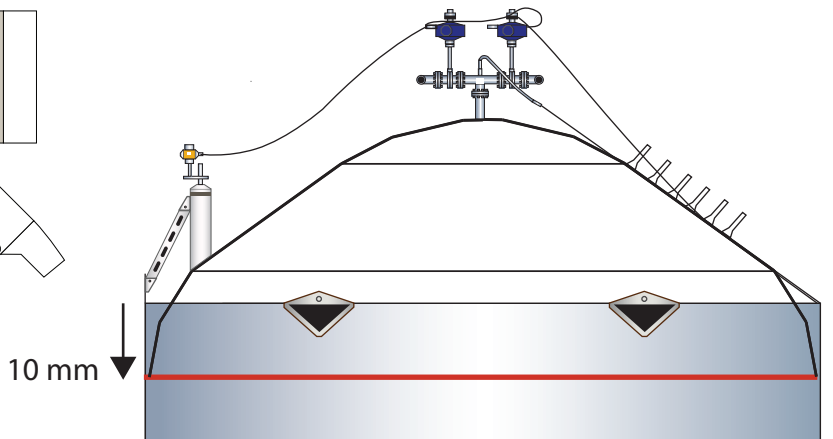
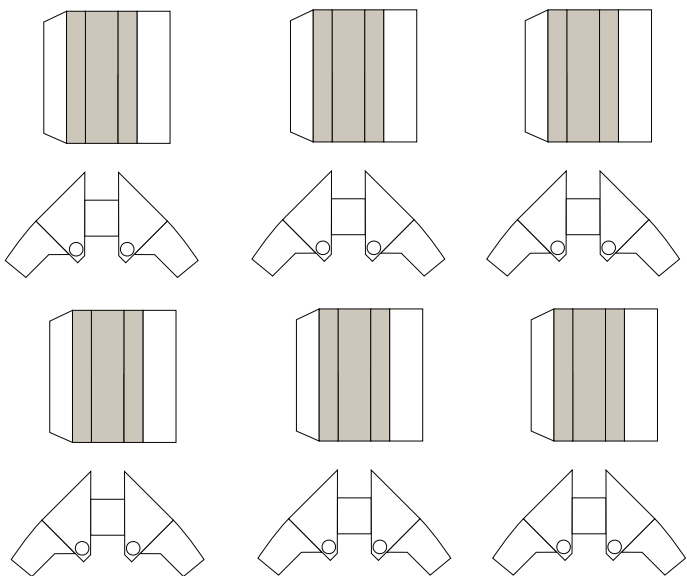



1:100 Scale

1 cm

1 inch

# SpaceX Starship SN7.1

Print on Cardstock (110 lbs)

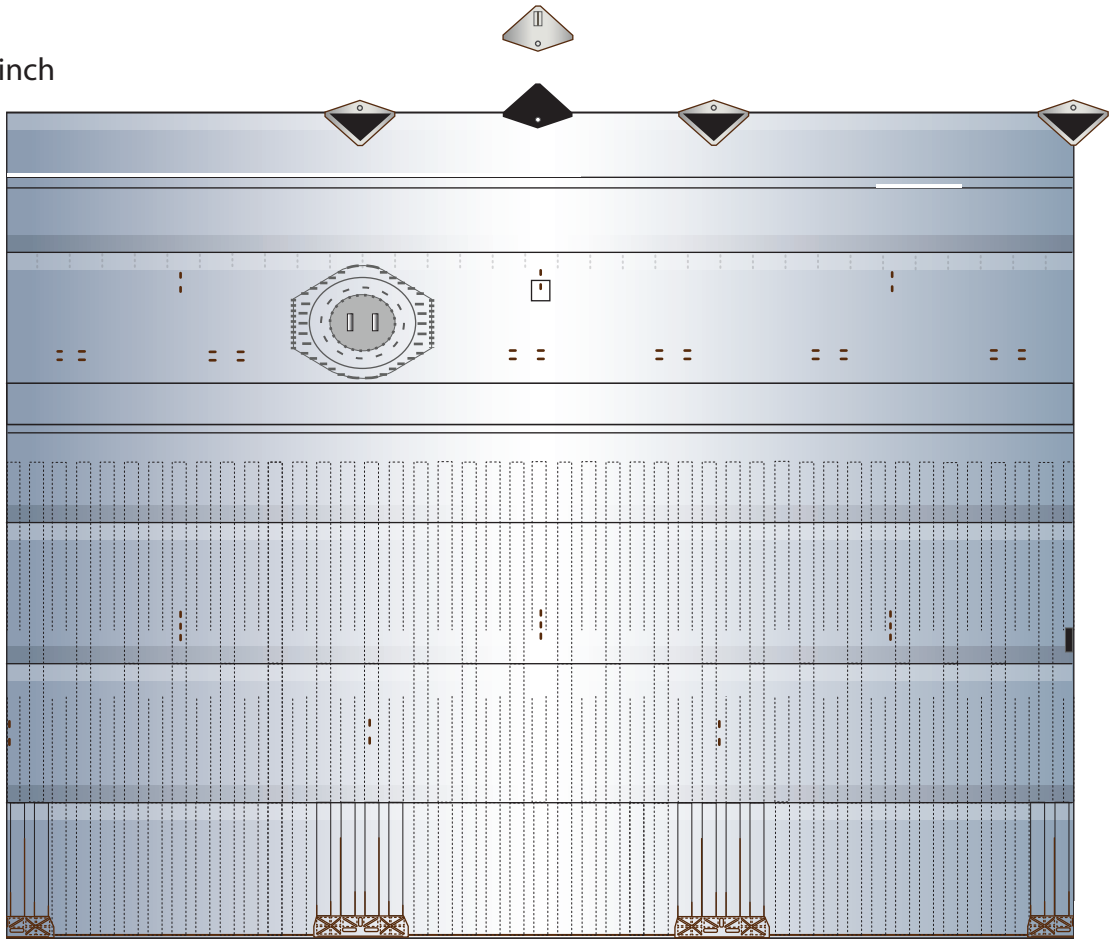
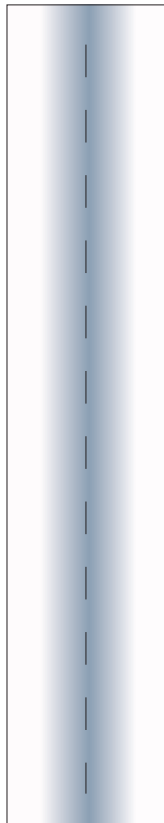
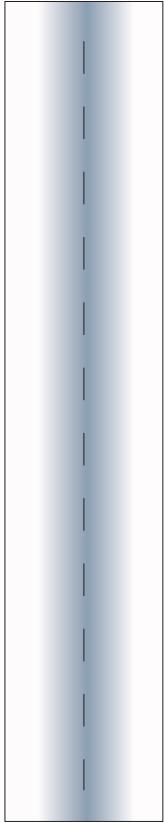

Front

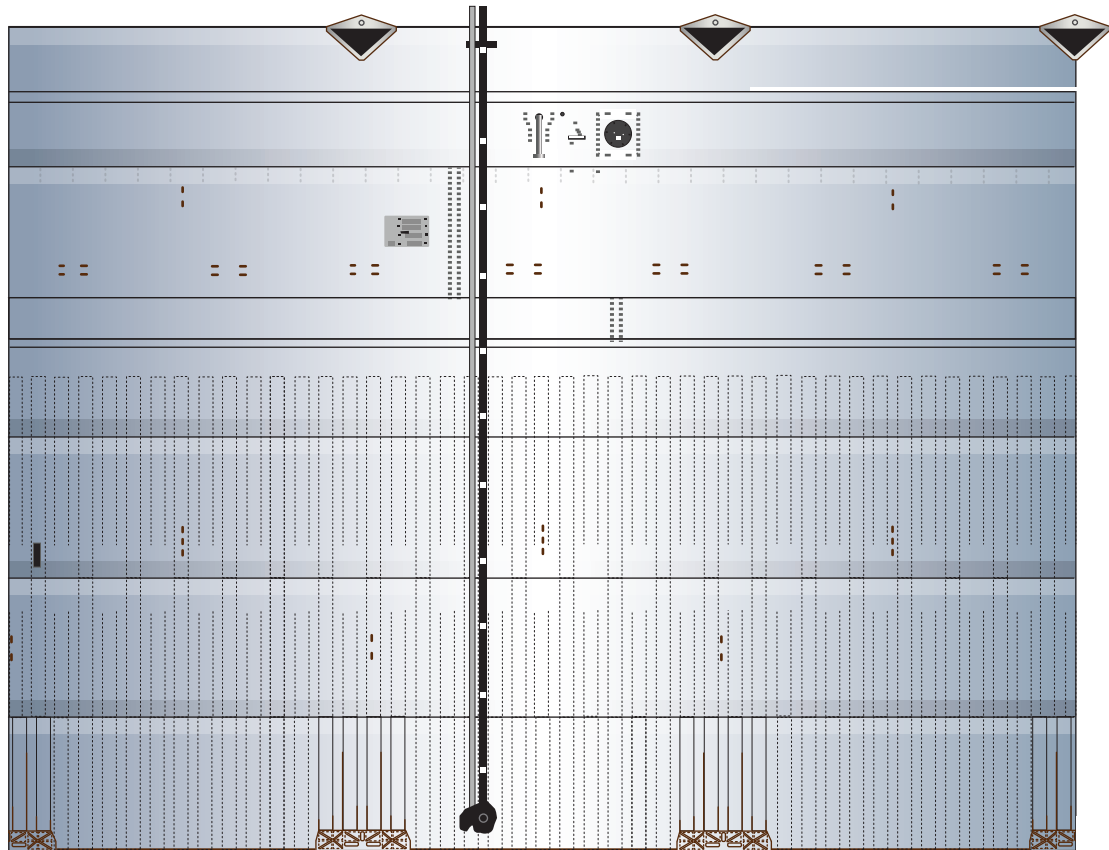

Back



1:100 Scale



# SpaceX Starship SN 7.1

Print on Cardstock (110 lbs)

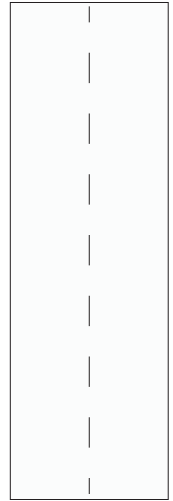
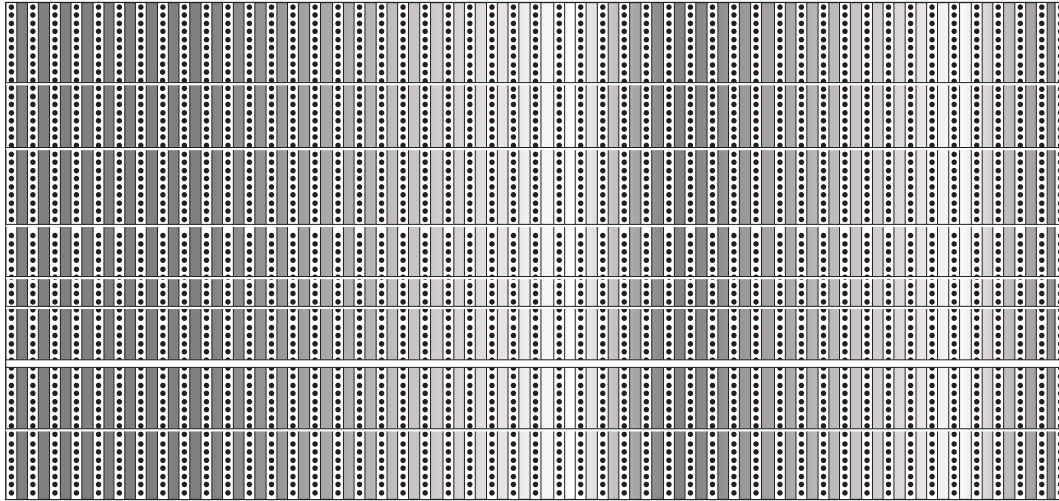

Engine section  
interior wall

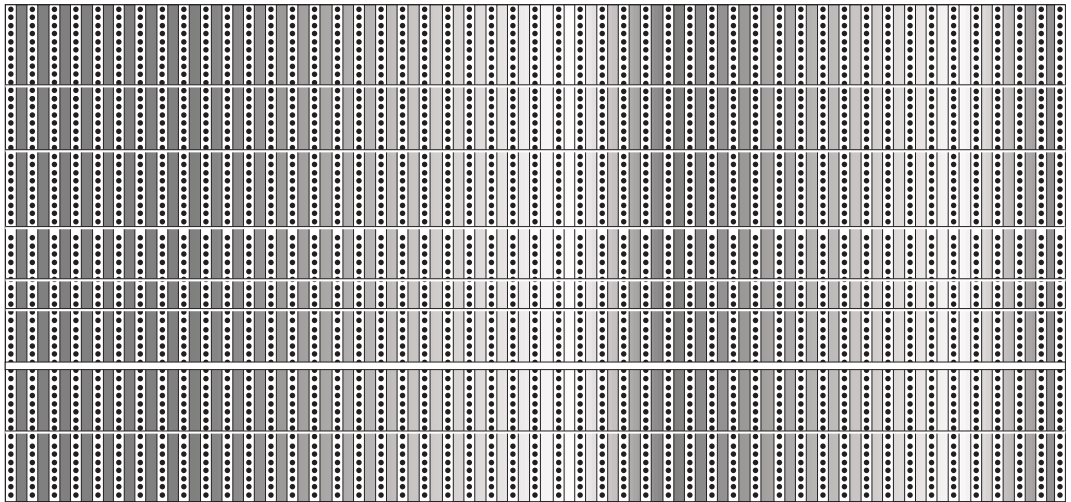



1:100 Scale

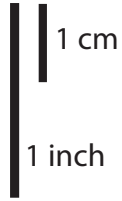

# SpaceX Starship SN 7.1

Print on Cardstock (110 lbs)

## Former for bulkhead

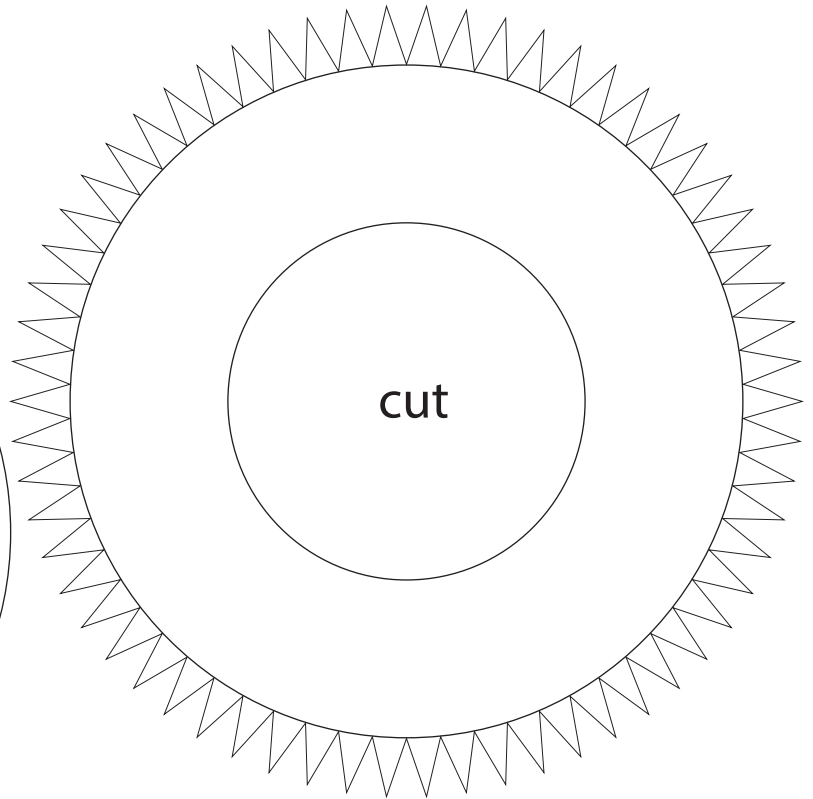
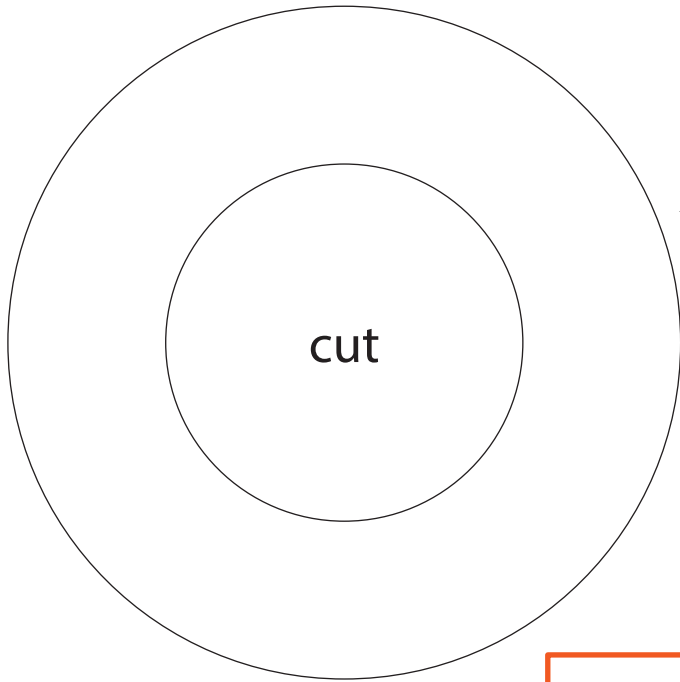

**IMPORTANT**  
Bottom former is glued 66 mm  
from bottom edge of lower body.

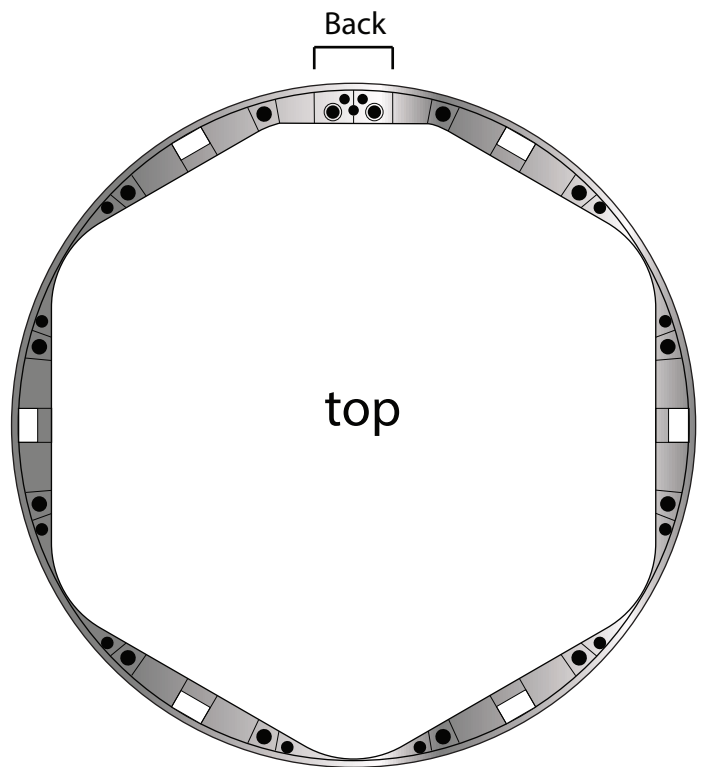
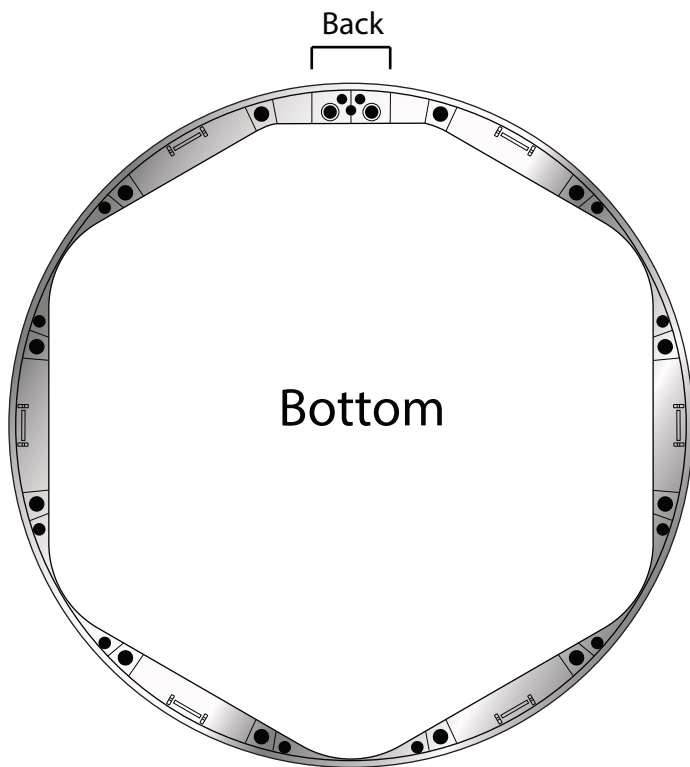





1 cm

1 inch

1:100 Scale

# Starship SN 7.1 Bulkhead

Print on Cardstock (110 lbs)

